

ShoreTel 230 IP Phone

Quick Install Guide & Warranty



Document and Software Copyrights

Copyright © 1998–2006 by ShoreTel, Inc., Sunnyvale, California, U.S.A. All rights reserved. Printed in the United States of America. Contents of this publication may not be reproduced or transmitted in any form or by any means, electronic or mechanical, for any purpose, without prior written authorization of ShoreTel, Inc.

ShoreTel, Inc. reserves the right to make changes without notice to the specifications and materials contained herein and shall not be responsible for any damage (including consequential) caused by reliance on the materials presented, including, but not limited to, typographical, arithmetic, or listing errors.

Trademarks

ShoreCare, ShoreWare and ShoreGear are registered trademarks of ShoreTel, Inc. in the United States and/or other countries. ShoreTel, ShoreTel 6, ShorePhone, Office Anywhere and ShoreTel Smart are trademarks of ShoreTel, Inc. in the United States and/or other countries.

Microsoft, Windows, Windows NT, and ActiveX are either registered trademarks or trademarks of Microsoft Corporation in the United States and/or other countries. VxWorks is a trademark of Wind River Systems. All other copyrights and trademarks herein are the property of their respective owners.

Version Information

PN 800-1045-02
ShoreTel IP230 Quick Install Guide & Warranty
Date: February 28, 2006

Company Information

ShoreTel, Inc.
960 Stewart Drive
Sunnyvale, California 94085

Phone: +1-408-331-3300 OR from within United States 1-800-425-9385
Fax: +1-408-331-3333

www.shoretel.com

1 Attach phone to base

a Insert the large tab on the mount into the slot on the rear of the phone.

b Rotate the two pillars down until the smaller tabs slide into the slots.

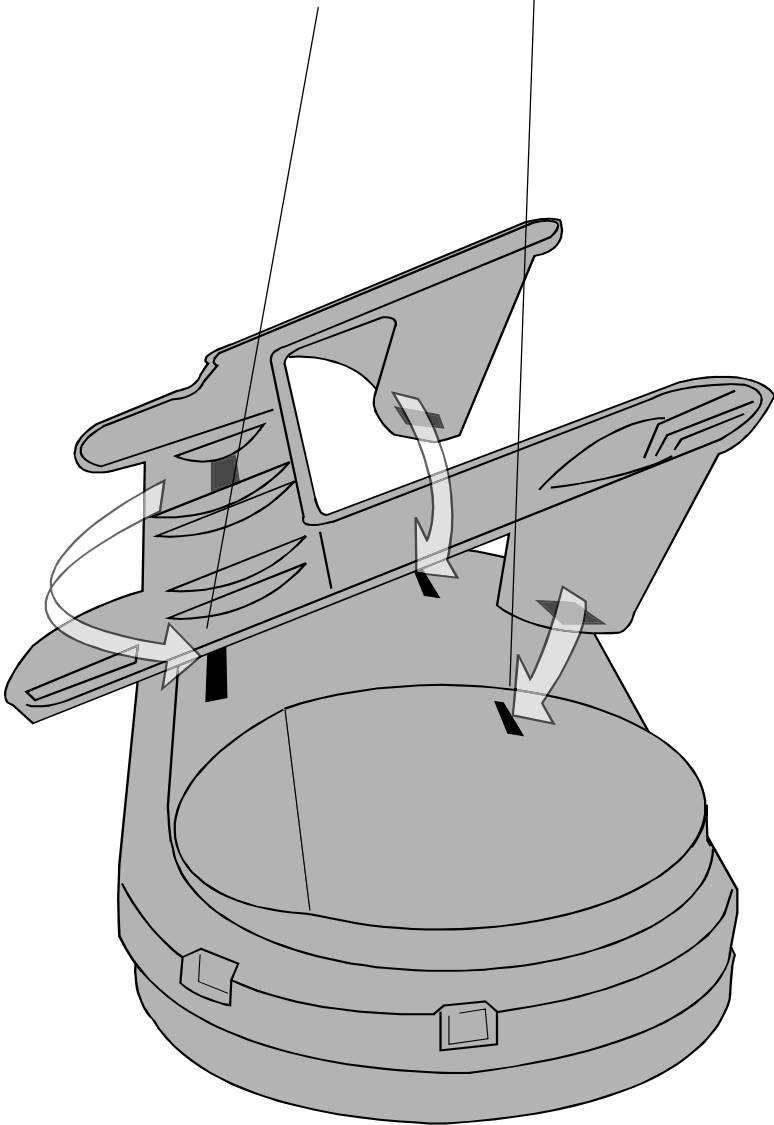

2a Connect to powered network

(no AC adapter required)

If the LAN supports power-over-Ethernet, no AC adapter is needed. The phone draws power from the Ethernet network.

Connect the network cable between the LAN port on the back of the phone and an Ethernet jack in the workspace (or on a data switch/router that supports Power-over-Ethernet).

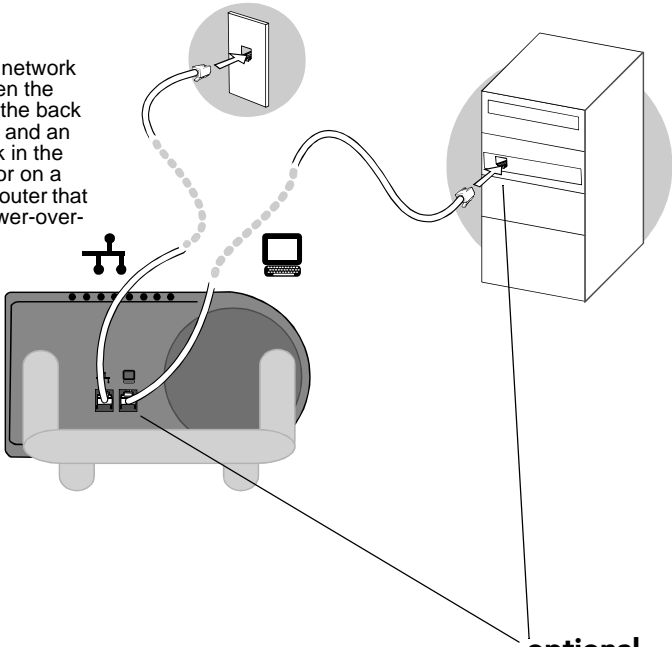

optional

Share a single LAN wall jack between your IP phone and computer by daisy-chaining the PC off the second Ethernet port on your phone. (The phone connects to the wall jack and the PC connects to the phone.)

2b Connect to power & network

(Non-powered Ethernet network requires AC power adapter)

- c** Connect the AC power cable between the adapter and an electrical socket.

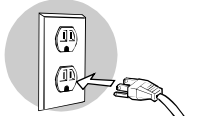

Upper LED*** lights green to indicate when phone is connected and using power.

- b** Connect the second network cable to the DATA IN port** on the adapter and an Ethernet jack in the workspace (or on a data switch/router).

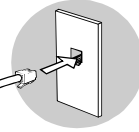

Lower LED lights green to indicate adapter has AC power.

- a** Connect a network cable to the DATA & POWER OUT port * on the adapter. The other end goes to the LAN port on the phone.

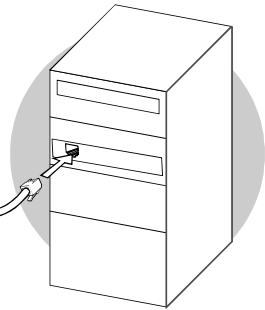
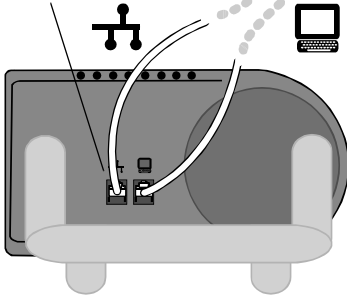

optional

Share a single LAN wall jack between your IP phone and computer by daisy-chaining the PC off the second Ethernet port on your phone. (The phone connects to the wall jack and the PC connects to the phone.)

* ON SOME ADAPTERS, THIS PORT MAY BE LABELED "DATA & PWR" OR "PHONE."

** ON SOME ADAPTERS, THIS PORT MAY BE LABELED "DATA" OR "NETWORK."

*** SOME ADAPTERS MAY HAVE ONLY ONE LED.

3 Connect handset

For optimal use, attach the longer end of the handset cable to the handset.

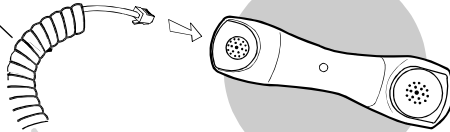

Connect the short end of the handset cable to the jack on the phone body.

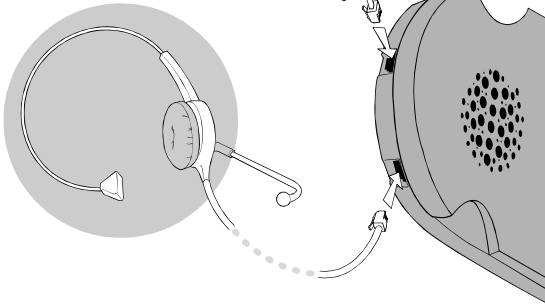

optional

Connect a headset to connector on phone.
Headset not included.

Important Safety Instructions

For IP TELEPHONE MODELS 110, 212k, 230, 560, 560g, BB24



This symbol is to alert you to important operating or servicing instructions that may appear in this owner's manual.

Always follow basic safety precautions when using this product to reduce the risk of injury, fire, or electric shock.

- Read and understand all instructions in this manual. Observe all markings on the products.
- Follow all warnings and instructions marked on this product.
- For information on proper mounting instructions, consult the manual provided with this product.
- This product should be operated only from the type of power source indicated on the marking label.
- Telecommunication metallic-type connections are not intended to leave the building premises unless connected to other telecommunication devices that provide primary and secondary protection as applicable.
- To reduce the risk of electrical shock, do not disassemble this product. Service should be performed by trained personnel only. Opening or removing covers and/or circuit boards may expose you to dangerous voltages or other risks. Incorrect re-assembly can cause electrical shock when the unit is subsequently used.
- If this product has a three-prong (grounding) plug or a polarized plug with one wide prong, it may not fit in non-polarized outlets. Do not defeat the purpose of these plugs. If they do not fit in your outlet, the outlet should be replaced by an electrician.
- Install this product in a protected location where no one can trip over any line or power cord. Protect cords from damage or abrasion.
- Unplug this product from the wall outlet before cleaning. Do not use liquid cleaners or aerosol cleaners. Use a damp cloth for cleaning.
- Do not allow anything to rest on the power cord. Do not locate this product where the cord will be abused by persons walking on it.
- Do not overload wall outlets and extension cords as this can result in the risk of fire or electrical shock.
- Unplug this product from the wall outlet and contact qualified technicians to service the unit if the any of the following conditions occur:
 - a) When the power supply cord or plug is damaged or frayed.
 - b) If liquid has been spilled into the product.
 - c) If the product has been exposed to rain or water.
 - d) If the product does not operate normally by following the operating instructions. Adjust only those controls that are covered by the operating instructions because improper adjustment of other controls may result in damage, and will often require extensive work by qualified technician to restore the product to normal operation.
 - e) If the product has been dropped and exhibits a distinct change in performance.
- Warning: Small metal objects may be retained in the earcap region.

SAVE THESE INSTRUCTIONS

Warranty and Limitation of Liability

LIMITED WARRANTY. ShoreTel warrants to the end user (“Customer”) that this product will be free from defects in workmanship and materials, under normal use and service, for one year from the date of purchase from ShoreTel or its authorized reseller. ShoreTel's sole obligation under this express warranty shall be, at ShoreTel's option and expense, to repair the defective product or part, deliver to Customer an equivalent product or part to replace the defective item, or if neither of the two foregoing options is reasonably available, ShoreTel may, in its sole discretion, refund to Customer the purchase price paid for the defective product. All products that are replaced will become the property of ShoreTel. Replacement products or parts may be new or reconditioned. ShoreTel warrants any replaced or repaired product or part for ninety (90) days from shipment, or the remainder of the initial warranty period, whichever is longer.

Products returned to ShoreTel must be sent prepaid and packaged appropriately for safe shipment, and it is recommended that they be insured or sent by a method that provides for tracking of the package. Responsibility for loss or damage does not transfer to ShoreTel until the returned item is received by ShoreTel. The repaired or replaced item will be shipped to Customer, at ShoreTel's expense, not later than thirty (30) days after ShoreTel receives the defective product, and ShoreTel will retain risk of loss or damage until the item is delivered to Customer.

EXCLUSIONS. ShoreTel will not be liable under this limited warranty if its testing and examination disclose that the alleged defect or malfunction in the product does not exist or results from:

- Failure to follow ShoreTel's installation, operation, or maintenance instructions.
- Unauthorized product modification or alteration.
- Unauthorized use of common carrier communication services accessed through the product.
- Abuse, misuse, negligent acts, or omissions of Customer and persons under Customer's control or
- Acts of third parties, acts of God, accident, fire, lightning, power surges or outages, or other hazards.

WARRANTY EXCLUSIVE. IF A SHORETEL PRODUCT DOES NOT OPERATE AS WARRANTED ABOVE, CUSTOMER'S SOLE REMEDY FOR BREACH OF THAT WARRANTY SHALL BE REPAIR, REPLACEMENT, OR REFUND OF THE PURCHASE PRICE PAID, AT SHORETEL'S OPTION. TO THE FULL EXTENT ALLOWED BY LAW, THE FOREGOING WARRANTIES AND REMEDIES ARE EXCLUSIVE AND ARE IN LIEU OF ALL OTHER WARRANTIES, TERMS, OR CONDITIONS, EXPRESS OR IMPLIED, EITHER IN FACT OR BY OPERATION OF LAW, STATUTORY OR OTHERWISE, INCLUDING WARRANTIES, TERMS, OR CONDITIONS OF MERCHANTABILITY, FITNESS FOR A PARTICULAR PURPOSE, SATISFACTORY QUALITY, CORRESPONDENCE WITH DESCRIPTION, AND NON-INFRINGEMENT, ALL OF WHICH ARE EXPRESSLY DISCLAIMED. SHORETEL NEITHER ASSUMES NOR AUTHORIZES ANY OTHER PERSON TO ASSUME FOR IT ANY OTHER LIABILITY IN CONNECTION WITH THE SALE, INSTALLATION, MAINTENANCE, OR USE OF ITS PRODUCTS.

SERVICE AGREEMENTS. Please contact your ShoreTel Authorized Reseller for information about service agreements applicable to your product.

LIMITATION OF LIABILITY. TO THE FULL EXTENT ALLOWED BY LAW, SHORETEL EXCLUDES FOR ITSELF AND ITS SUPPLIERS ANY LIABILITY, WHETHER BASED IN CONTRACT OR TORT (INCLUDING NEGLIGENCE), FOR INCIDENTAL, CONSEQUENTIAL, INDIRECT, SPECIAL, OR PUNITIVE DAMAGES OF ANY KIND, OR FOR LOSS OF REVENUE OR PROFITS, LOSS OF BUSINESS, LOSS OF INFORMATION OR DATA, OR OTHER FINANCIAL LOSS ARISING OUT OF OR IN CONNECTION WITH THE SALE, INSTALLATION, MAINTENANCE, USE, PERFORMANCE, FAILURE, OR INTERRUPTION OF ITS PRODUCTS, EVEN IF SHORETEL OR ITS AUTHORIZED RESELLER HAS BEEN ADVISED OF THE POSSIBILITY OF SUCH DAMAGES, AND LIMITS ITS LIABILITY TO REPAIR, REPLACEMENT, OR REFUND OF THE PURCHASE

PRICE PAID, AT SHORETEL'S OPTION. THIS DISCLAIMER OF LIABILITY FOR DAMAGES WILL NOT BE AFFECTED IF ANY REMEDY PROVIDED HEREIN SHALL FAIL OF ITS ESSENTIAL PURPOSE.

DISCLAIMER. Some countries, states, or provinces do not allow the exclusion or limitation of implied warranties or the limitation of incidental or consequential damages for certain products supplied to consumers, or the limitation of liability for personal injury, so the above limitations and exclusions may be limited in their application to you. When the implied warranties are not allowed to be excluded in their entirety, they will be limited to the duration of the applicable written warranty. This warranty gives you specific legal rights, which may vary depending on local law.

GOVERNING LAW. This Limited Warranty and Limitation of Liability shall be governed by the laws of the State of California, U.S.A., and by the laws of the United States, excluding their conflicts of laws principles. The United Nations Convention on Contracts for the International Sale of Goods is hereby excluded in its entirety from application to this Limited Warranty and Limitation of Liability.

Safety and Regulatory Information

This device complies with part 15 of the FCC Rules. Operation is subject to the following two conditions:

- (1) This device may not cause harmful interference, and
- (2) This device must accept any interference received, including interference that may cause undesired operation.

NOTE: This equipment has been tested and found to comply with the limits for a Class B digital device, pursuant to part 15 of the FCC Rules. These limits are designed to provide reasonable protection against harmful interference when the equipment is operated in a commercial environment. This equipment generates, uses, and can radiate radio frequency energy and, if not installed and used in accordance with the instruction manual, may cause harmful interference to radio communications. Operation of this equipment in a residential area is likely to cause harmful interference, in which case the user will be required to correct the interference at his own expense.

This ShoreTel IP Phone has been marked with the CE mark. This mark indicates compliance with EEC directories 89/336/EEC and 73/23/EEC. A full copy of the Declaration of Conformity can be obtained from ShoreTel Inc., 960 Stewart Drive, Sunnyvale, CA, USA 95054.

In accordance with part 15 of the FCC rules, the user is cautioned that any changes or modifications not expressly approved by ShoreTel, Inc. could void the user's authority to operate this equipment.

Installation must be performed in accordance with all relevant national wiring rules.

L'installation doit être exécutée conformément à tous les règlements nationaux applicable au filage électrique.

The outlet to which this apparatus is connected must be installed near the equipment and must always be readily accessible.

La sortie à la quelle l'appareil est branchée doit être installée près de l'équipement et doit toujours être facilement accessible.

This Class [B] digital apparatus complies with Canadian ICES-003.

C'est appareil numérique de la classe [B] est conforme à la norme NMB-003 du Canada.

Copyright. All rights reserved under International and pan-American Copyright Conventions. No part of the contents of this manual may be copied, reproduced, or transmitted in any form or by any means, or translated into another language or format, in whole or part, without written consent of ShoreTel, Inc. ShoreTel® and the logo design

are registered trademarks and ShoreTel® IP is a trademark of ShoreTel, Inc. in the United States, and various countries.

Do not remove (or allow any third party to remove) any product identification, copyright, or other notices. The software contained within this product is protected by United States copyright laws and international treaty provisions. ShoreTel, Inc., retains title and ownership of all property rights with respect to the software within this product.